

vibro-meter

MEGGITT



# **vibro-meter solutions portfolio**

Advanced condition monitoring  
& machinery protection  
for critical rotating machinery

## Contents

3	Introduction
4	A new era
6	From Sensors to answers
8	Solution Portfolio
10	Expert article
16	<b>VM600<sup>Mk2</sup></b>
18	Features
19	MPC4 <sup>Mk2</sup>
20	Architecture
22	<b>VibroSmart</b>
24	Features
25	Architecture
26	<b>VibroSight</b>
28	Features
29	Architecture
30	Applications

# Advanced machinery protection and condition monitoring for turbomachinery.

Learn more about Meggitt and our proud tradition of innovation and excellence.

<https://meggittsensing.com/energy/>



## Your preferred partner for innovative and high-quality monitoring solutions

The Meggitt facility in Fribourg, Switzerland, designs and manufactures complete condition monitoring, vibration monitoring, and measurement solutions for the energy and aerospace industries.

Since its foundation in 1952 as Vibro-Meter, our products and expertise have enabled superior solutions for the sensing and monitoring of vibration, pressure, air gap and other essential parameters in critical plants and equipment. Today, our solutions are trusted by major OEMs globally and have become standard-fit components on machinery used in Power Generation, Oil & Gas and other industrial applications.

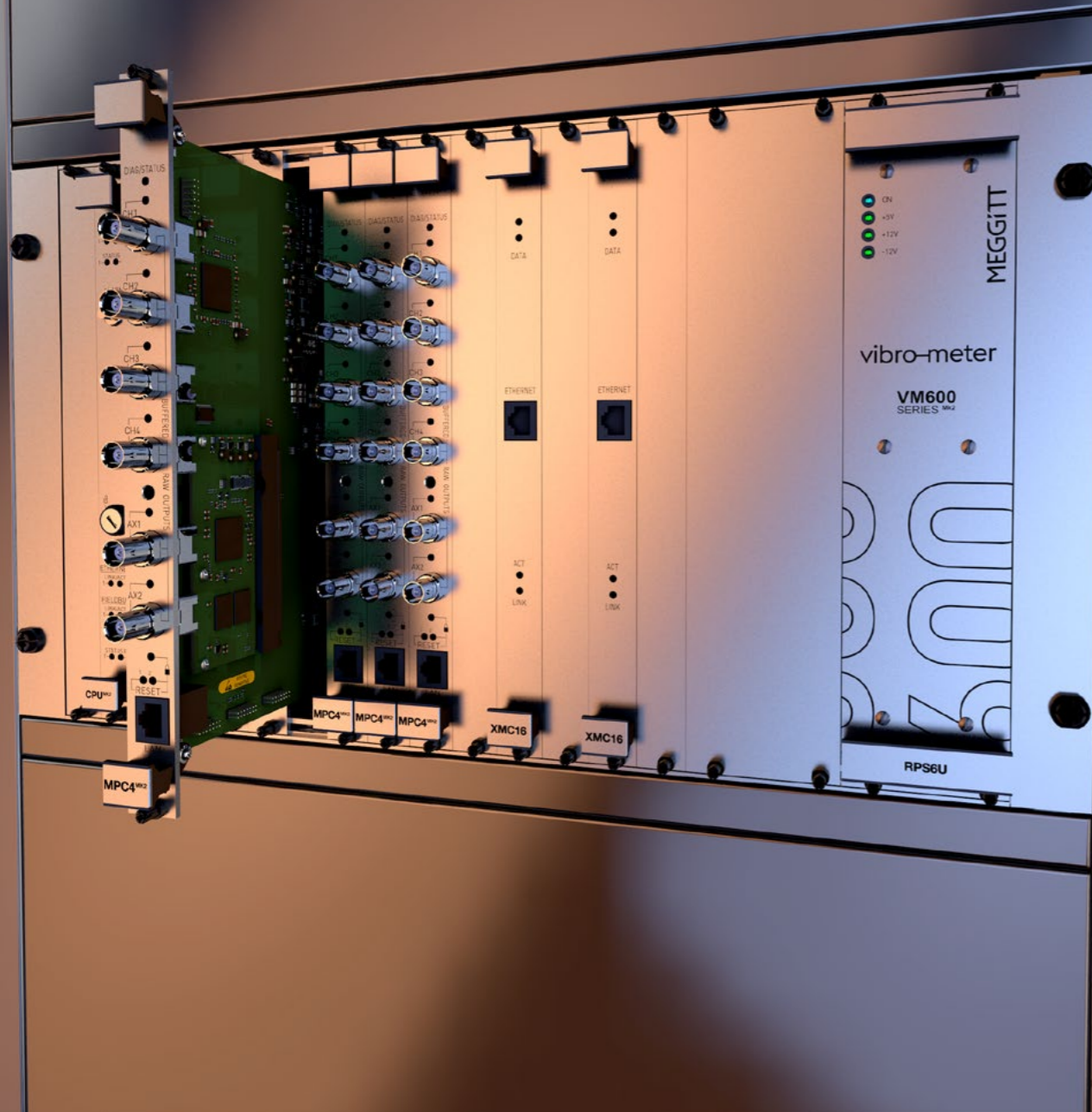

**"With the VM600<sup>Mk2</sup>, we've taken great care to ensure that new customers receive the most powerful technology in a field-proven architecture."**

### Shaping the future with our DNA

With an installed base of more than 8,000 systems globally, our VM600 machinery monitoring system made waves in the industry when it was introduced, more than 20 years ago.

As we now proudly introduce the VM600<sup>Mk2</sup>, we've made sure to revitalize a classic architecture and revisit the platform brand and design.

VM600<sup>Mk2</sup> is the translation of vibro-meter's legacy, precision and strengths - values that are at the core of our DNA.

## A new era

**When we introduced the VM600 platform in 2000, we "broke the mold" by moving away from application-specific modules.**

The industry paradigm at that time was generally one module for accelerometers, another for velocity sensors, another for proximity sensors, another for thrust, still another for case expansion, yet another for speed, etc. There were even different modules for RMS versus peak measurements. In fact, at that time, competing platforms had as many as 120 different module combinations when the monitor card plus I/O card was considered. It made for a substantial spare parts burden as well as substantial training on so many different permutations.

Although the situation was getting moderately better under newer platforms, we were the first company to introduce a truly "universal" module capable of addressing all measurements except temperature in a single piece of hardware. It even had self-contained relays and two "auxiliary" channels that could be used for speed / phase reference sensors. It was truly a self-contained, 4-channel machinery protection system on a single card. The rack chassis needed to do little more than supply power and act as a mechanical holder for multiple modules. We called it the MPC4 (Machine Protection Card - 4 channel), but in reality it could accommodate 6 channels (4 universal channels + 2 speed channels). If we had to rename it today, in fact, we would probably call it the MPC4+2.

The "one card does it all" approach turned out to be groundbreaking. They say that imitation is the sincerest form of flattery, and

**"we take it as a very high compliment that many other companies have now followed our lead with their own versions of universal modules"**

but few quite so universal as ours even though they have had more than 20 years to catch up.

As we set out to develop a 2nd generation platform, we knew this universal module concept had to remain part of what made the original VM600 so successful. It was time to be innovative once again - but in a different way. Where in the late 1990s we "broke the mold" in our design by moving to a completely different approach of "one card does it all", this time we needed to be innovative by delivering improved functionality without heavily inconveniencing our customers.

As we looked at the existing architecture, we realized that an entirely new system wasn't necessary - merely new cards. Cards that could use the same backplane, same chassis, and same power supplies. Cards that would combine the machinery protection functions more tightly with the condition monitoring functions, yet



Our 2nd generation VM600 platform introduces (L to R) the MPC4<sup>Mk2</sup>, CPUM<sup>Mk2</sup>, and RLC16<sup>Mk2</sup> modules along with companion I/O cards.

without creating vulnerabilities. Cards that would meet stringent IEC 62443 requirements along with SIL-2 certification for those customers that need vibration-related measurements as part of a safety instrumented system. Cards that provided more flexibility with its on-board relays. And cards that could use modern, ethernet communications.

With the VM600<sup>Mk2</sup>, we've taken great care to ensure that new customers receive the most powerful technology in a field-proven architecture. But we've also made sure that no customer is left behind as the only path to improved performance and improved value. The VM600<sup>Mk2</sup> gives you the opportunity to refresh aging modules that may have reached the end of their useful lifecycle with new modules offering better functionality and performance, yet all while retaining the same chassis and wiring.

In this brochure you will learn more about vibro-meter's new solution for a new era ...

# Sensing technology for turbomachinery.



## Sensors & signal conditioners

Our comprehensive range of sensors and measurement chains can be used with our monitoring system hardware and software (or third-party systems) in order to provide complete solutions for the monitoring and protection of critical machines and processes.

From standard to harsh industrial environments, including hazardous areas and/or extreme temperatures (up to 700°C).

**"vibro-meter has one of the widest ranges of sensors for harsh industrial environments and extensive knowledge of the measurements for machinery monitoring."**

## From sensors to answers

With one common data visualization, event management, and diagnostic platform, plant operators can choose the system that suits their requirements.

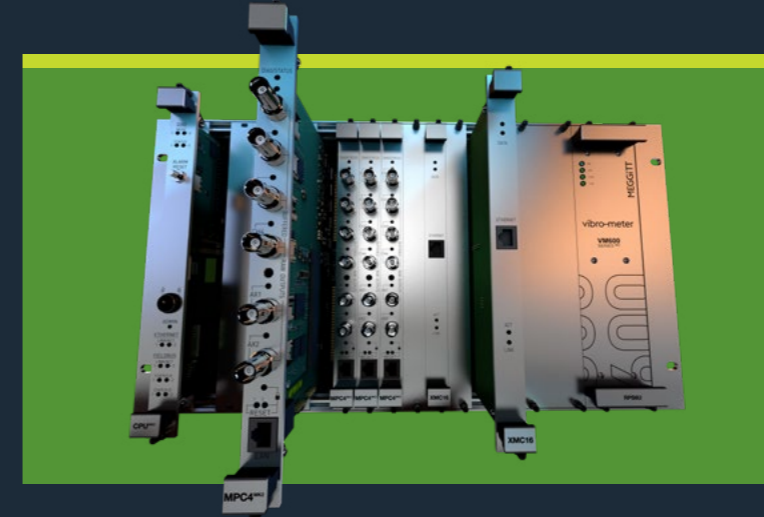

### VM600<sup>Mk2</sup>

Centralized and modular machinery protection, condition monitoring for vibration and combustion applications from medium to high channel counts.

Typically used for larger gas and steam turbines and plants often including a larger quantity of balance-of-plant equipment.



### VibroSmart

Distributed condition and machinery protection for vibration and combustion applications on power generation turbines and auxiliary balance-of-plant equipment.

Modules can be mounted directly on machinery, eliminating the need for costly cabling.



### VibroSight

A common software platform for the configuration, operation and management of VM600<sup>Mk2</sup> and VibroSmart systems.

Fast and powerful, user-friendly software with an extensive plot catalogue for online and offline data visualisation and analysis.

# Solution portfolio

## Plant-wide ecosystems integration

### Local or remote monitoring center

Capability to safely transfer acquired data in quasi real-time through a data diode to a remote monitoring center for data analysis and archiving.



SECURE REMOTE CONNECTION



### VibroSight

With one common data visualization, event management and diagnostic platform, plant operators can choose the system or combination of systems that suit the requirements of a given plant.

### Plant Control System

Capability to communicate with third party systems like a PLC or external relays via industry standard protocols like Modbus, Profibus or IEC61850 GOOSE.



FIELDBUS

ETHERNET

### VM600Mk2

Centralized and modular architecture with a higher channel density that addresses complex installations. Dynamic inputs from proximity probes, accelerometers, velocity, dynamic and pressure sensors are fed into standard 19-inch, 6U racks.



### VibroSmart

A distributed architecture with a lower channel density. Inputs from all sensors are wired to modules typically installed in an industrial housing or cabinet, closer to or on the machinery being monitored. As a result, sensor cabling is effectively replaced by Ethernet cabling, thereby reducing installation costs.



SENSOR SIGNALS

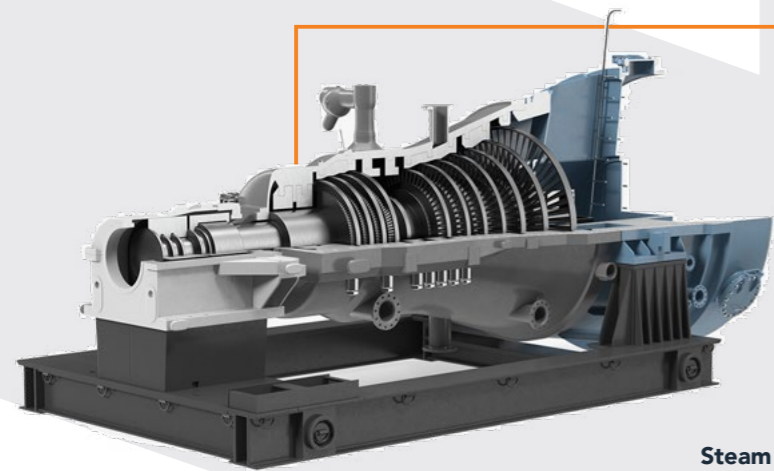

### Steam & Gas Turbine

The measurement chain starts with vibro-meter's high temperature, high sensitivity dynamic pressure sensors which can survive indefinitely within harsh environments, plant operators can monitor virtually every parameter necessary to provide detailed information on equipment condition.

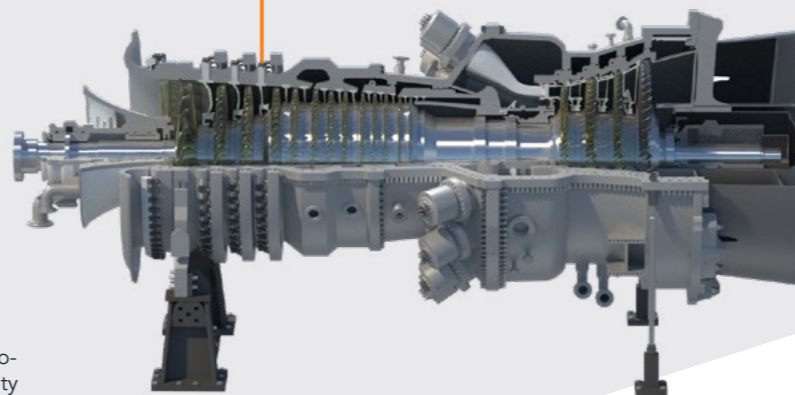

### BOP

Our distributed monitoring system pioneering architecture is an ideal solution to the dispersed nature of balance-of-plant equipment without compromising the protection and monitoring of the critical machinery.

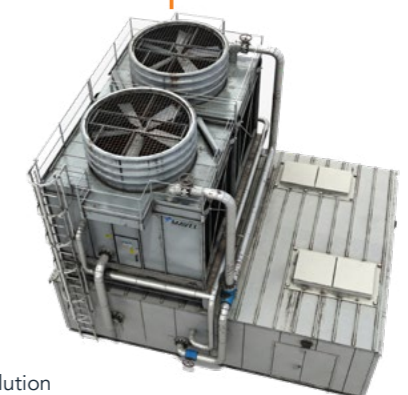

# Expert article

## Integrating a machinery monitoring system into a plant-wide ecosystem.

### Best practices for connecting to process control, machine control, and condition monitoring systems.

Thirty years ago, the phrase “islands of automation” was commonplace. It was used to describe instrument and control systems that exhibited very poor connectivity and were thus “islands unto themselves”.

What little connectivity existed might consist only of analog 4-20 mA outputs or discrete signals from relays. Although the phrase may not be as common these days, the ability to properly connect systems to one another remains a concern.

However, where at one time connectivity may have meant simply fitting a platform with the right digital protocol so that it could talk to other systems, the issue of cybersecurity is today a primary concern where it wasn't even in the dictionary three decades ago.

Indeed, the issue in the past could normally be overcome by selecting from among the various digital communication protocols used in industrial automation: Profibus, Modbus, ControlNet, Foundation Fieldbus, HART, OPC, etc.

Manufacturers had to decide which of these to support in their instruments, users needed to decide which ones to use, and third-party entities sprang up in abundance with hardware protocol converters and software that gave rise to the term “middleware” and could be used to allow systems with dissimilar protocols to communicate.

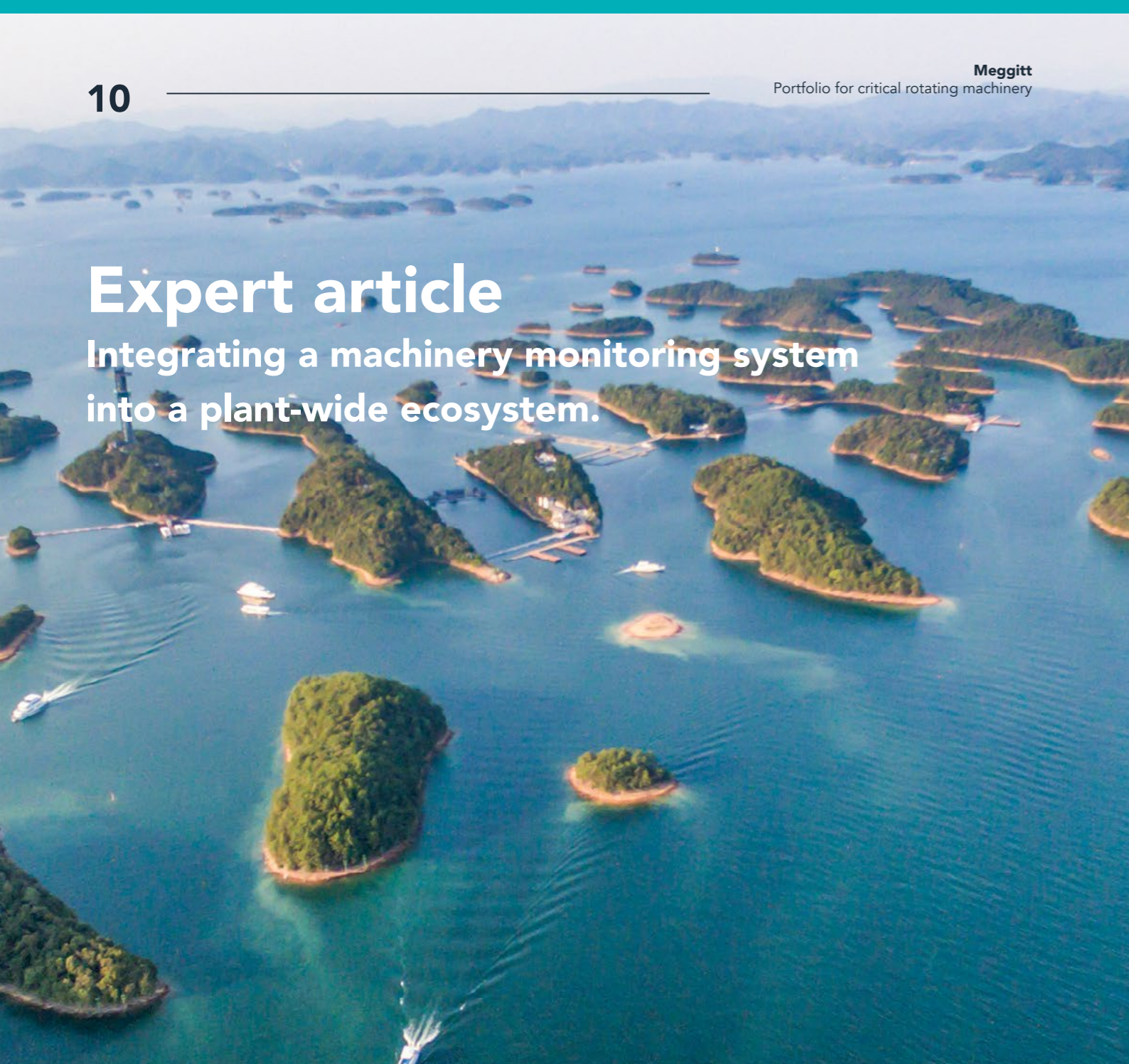

### Secure, functional connectivity

A typical plant has at least three other systems with which a machinery protection platform like the VM600 must be able to communicate:

1. The **Process Control System** (often a DCS)
2. The **Machine Control System** (often a PLC or purpose-built platform specifically for machinery control such as by the machine OEM or a supplier like Woodward, Compressor Controls Corporation, Tri-Sen, etc.)
3. The **Condition Monitoring System** (usually from the same supplier that provides the machinery protection system)

In addition to these three, there are other systems that touch rotating machines and must be considered as well. These include:

- The **Emergency Shutdown (ESD) System** which will often exist independently of the machine control system. Its task is to bring not only the machine, but the surrounding process to a safe state. Because it controls the shutdown of the process – and not just the machine – it is often separate and distinct from the machine control system and may well incorporate SIL ratings if implemented as part of risk reduction and process safety.
- The **Combustion Dynamics Monitoring System** which is generally present on all so-called “Low-NOx” gas turbines and often integrated tightly with (i.e., in the same chassis as) the machinery protection system. However, this system will not be present when the prime mover is something other than a gas turbine, or when the gas turbine does not use Low NOx combustor designs.

• The **Process Historian** (sometimes called “Operational Data Historian”) which is basically a large database that archives all of the data from the DCS plus instruments that may not send all of their available data to the DCS. The OSIsoft PI System is one popular example of a process historian. Others include the Yokogawa Exaquantum™ system, the AVEVA Historian (formerly Wonderware™), InfoPlus.21® from AspenTech, the SIMATIC Process Historian from Siemens, and many others.

Fundamentally, these systems take the quasi-static data produced by field instruments and allow the data to be trended and archived for many years rather than the shorter-term historical data (days, weeks, or months) available in the DCS's limited archive.

• The **Overspeed Protection (OSP) System** which is separate and distinct from the machine control system that controls speed. The OSP exists precisely because the speed control system may itself fail and a secondary system is needed to ensure that the machine cannot experience “run away” acceleration to speeds that would destroy it and damage property, the environment, and even human life.

Although this list is not exhaustive, it serves to illustrate the idea that the machinery protection system itself does not exist as an island in a typical plant and instead must communicate directly or indirectly with numerous other systems.

In the remainder of this article, we will address the four primary interfaces that are present where the VM600 platform is most often used: protective, process control, condition monitoring, and combustion dynamics.

### I. Machine Protective Interface

The protective interface consists of the signals that will be used to automatically trip a machine when it exceeds pre-determined alarm setpoints. There are usually two such alarms: ALERT and DANGER. In some instances, such as machinery standards from the American Petroleum Institute, these alarms are called HI and HI-HI (or LOW and LOW-LOW when an under-alarm is relevant). The highest level of alarm is often used to automatically trip the machine without the requirement for human intervention. The lower level of alarm is used to annunciate to operators that the machine is in distress and outside of normal operational bounds, even if not severe enough to warrant an automatic trip.

While at one time there was no such thing as digital communications protocols and the only way to connect such signals to the machine control system, DCS, or ESD was by means of hardwired relay outputs, this remains the preferred way to connect so-called “shutdown” or “trip” signals. Although this might seem like an antiquated way to make such connections, there are several reasons for this.

First, a relay is a very simple device that is unlikely to fail. Indeed, it can be programmed to “fail safe” if the consequences of a missed trip are sufficiently high. Fail safe generally means that the relay is normally energized and thus if it loses power for any reason, it will change state and thus trip the machine.

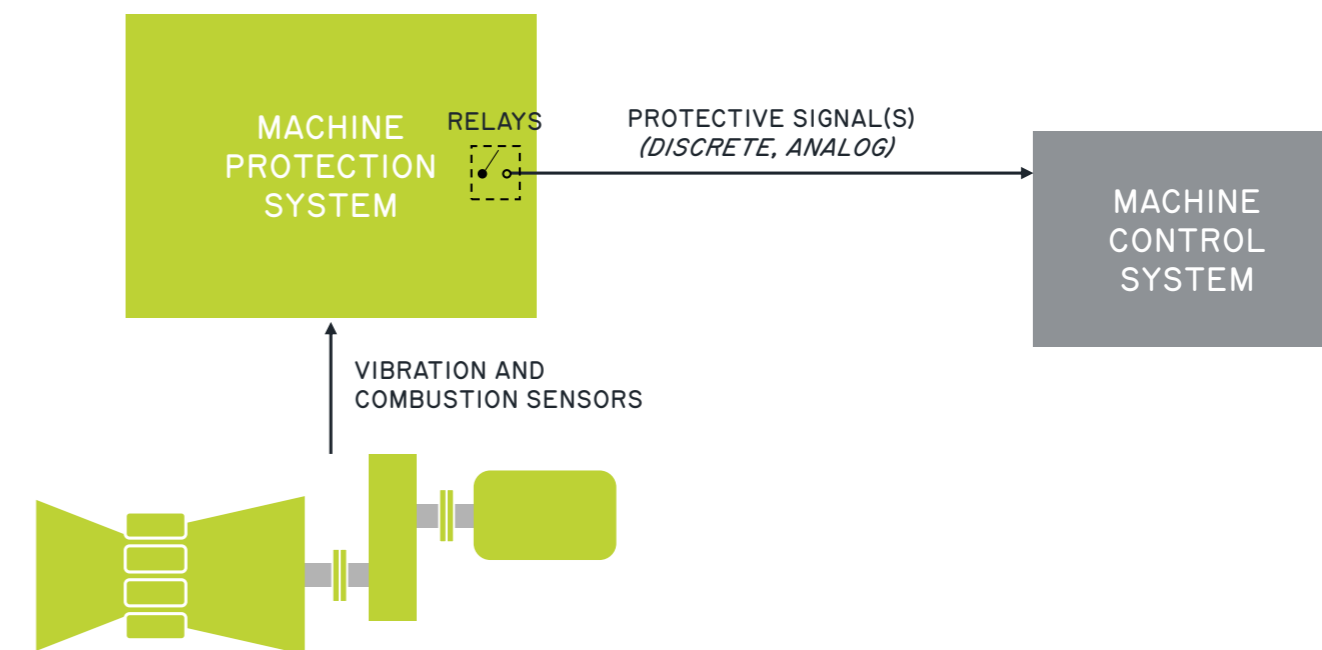

Hardwired relays remain the preferred and accepted way of interfacing the protective signals to the corresponding shutdown system such as an ESD or the machine control system; relays can often be hardwired directly to so-called “final control elements” such as a motor contact or valve that removes energy from the machine and thus stops it.

Second, relays can often be wired directly to a so-called "final control element" such as a fuel valve solenoid, a steam valve solenoid, an electric motor breaker (via an interposing relay), or other device such that no other system is required to fetch the status, interpret it, and take action to shut the machine down. It is thus very fast and can act within milliseconds to protect the machine.

In contrast, when the signal is sent digitally via a protocol like Modbus or Profibus, the interface itself is usually a computer of some kind (or even "middleware") that can stop communicating. Although redundant media (copper or fiber) can be used, there is often only redundant media and not redundant interfaces. Then, there must be digital "handshaking" between the machinery protection system and the connected system (such as a PLC or turbine control system) using a so-called "gateway" device that communicates using the selected digital protocol. Unless the scan time of the PLC has been set to look at these inputs or query its gateway several times per second, too much time can elapse between the protection system entering a DANGER condition and this making its way to the ultimate shutdown system.

Third, relays are generally capable of switching the control voltages required for tripping a machine without need of interposing hardware that creates latency and introduces additional cost. Thus, whether the shutdown signals will go directly to the machine control system, directly to the final control element on the machine itself (such as a steam valve), or to a separate ESD system, hardwired

relays are still considered good engineering practice. Indeed, API Standard 670 for machinery protection systems continues to preclude the use of digital protocols for protection, specifying the use of solid-state or electromechanical relays instead (refer to Std 670 sections 4.12 and 7.3). This is likely to persist into the 6th edition of the standard, currently in preparation.

II. Process Control System Interface

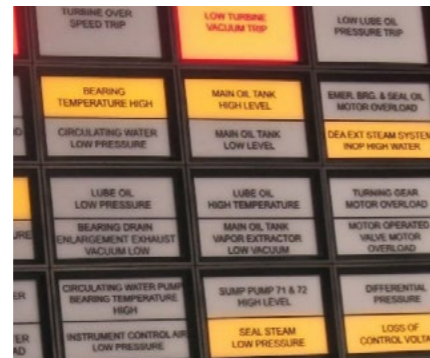

A typical annunciator panel found in machinery control panels and in plant control rooms. At one time, interfacing to such panels was done primarily by means of relay contacts. Today, it is more common for digital protocols to be used for sending status and values to the control room, whether directly to DCS screens or to an annunciator panel.

The interface with the process control system was at one time done entirely via analog hardwiring. Going far enough back in time, the vibration monitor itself was often located in the operator control

room and analog meter movements on the front of the protection system served as the human machine interface that gave operators current readings and alarm statuses. When racks were instead located remotely at the machine, relays were wired back to the control room and connected to annunciator panels similar to the one at right.

To complement statuses available via annunciator panels, trending was done via paper chart recorders and the most common interface between the protection system and such recorders was a proportional DC output – usually 4-20 mA but sometimes a true voltage signal such as 1-5 Vdc or 0-10 Vdc. These recorders literally traced out a trend on a slowly-moving piece of paper. With the advent of the DCS, such recorders became largely of historical interest and computer screens in the DCS console took the place of panel-mounted instruments such as annunciator panels and chart recorders. When the trends within DCS exceeded the available length, archival was done to the so-called process historian or operational data historian.

The link between the machinery protection system and the process control system thus moved away from analog hardwiring to digital protocols such as Profibus, Modbus, and others. At one time these protocols used purely serial communications but now more commonly employ industrial Ethernet communications, such as PROFINET and Modbus TCP.

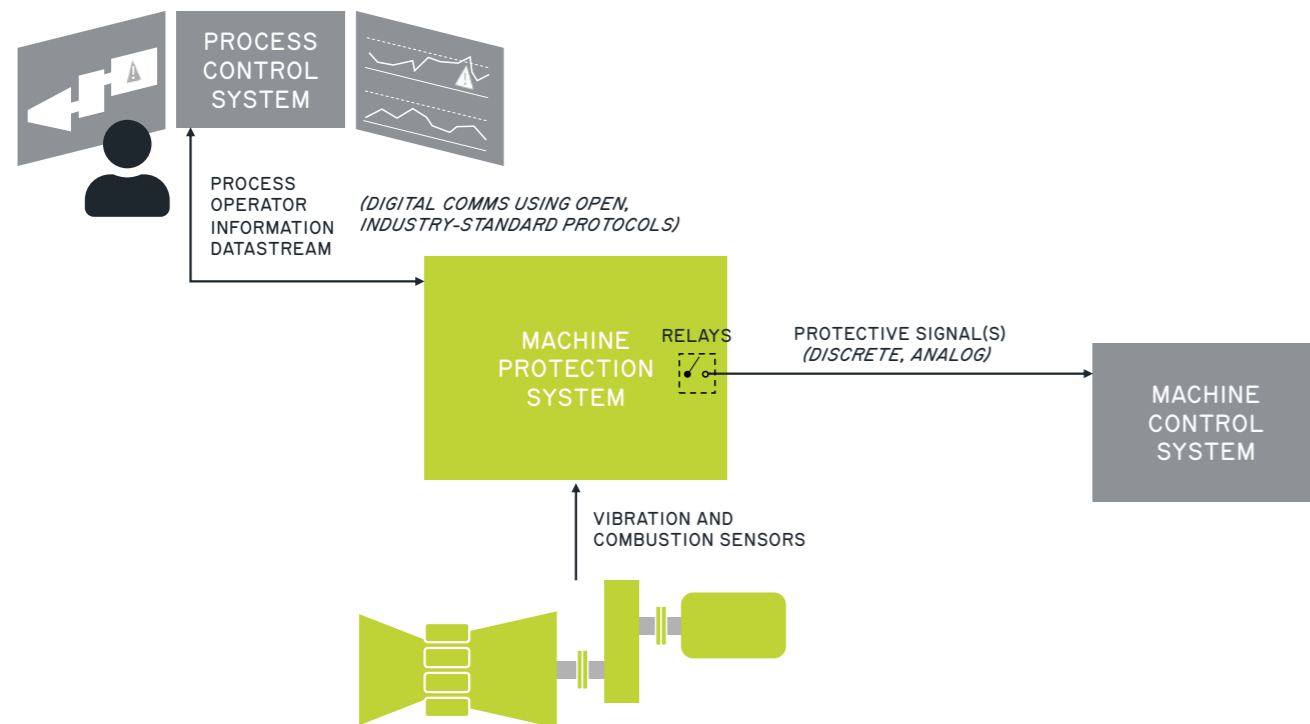

Because communications with the process control system (usually a DCS) provide operator information but are not used for auto-shutdown protective purposes, digital communication using open, industry-standard protocols such as Profibus and Modbus remains the preferred way of connecting the machinery protection system to the process control system. This link allows operators to see current values, alarm statuses, and trends.

Analog chart recorders were used for trending and could be circular, such as shown here, or linear on roll of paper in so called "strip chart" format. Image courtesy of Eurotherm Chessell.



Today, it is considered a best practice to employ digital communications between the protection system and the DCS (or PLC) for the purpose of displaying current values and statuses, and to allow trending of overall variables. It is important to recognize that these communication links are not used for carrying out shutdown commands and are instead considered "informational only".

Although it may be distressing for the operator to lose this communication link, it does not compromise the machinery protection functionality itself because that is hardwired via relays, as discussed in the previous section. Many operators choose to employ redundant media so that if a communications cable is cut, the other will continue to carry the necessary traffic. Indeed, some operators insist that redundant cables be segregated in different cable trays or underground conduit so that if one cable is cut or damaged, the other is not immediately adjacent and damaged as well. There are several reasons why digital communications are preferred.

The first is installation costs. Wiring statuses for two levels of alarm from every single channel can entail many wires. For example, consider a 24-channel monitoring system monitoring a machine with 20 radial vibration sensors, 2 axial position sensors, and 2 redundant phase triggers. If two alarm levels are set on all 24 channels, this corresponds to 48 relays, each with a twisted pair of wires to annunciate its condition.

If we add to this the overall vibration values that will be trended, this is another 24 wires with 4-20mA signals that must be wired; in other words, a total of 72 wires. The cost of this (analogue) wiring can be substantial and in some cases may exceed the cost of the machinery protection system itself.



The CPUMk2 is an example of a digital communications card designed to connect a machinery protection system to a process control system using standard, open protocols such as Profibus and Modbus. The card forms part of the new VM600Mk2 architecture from vibro-meter.

In contrast, a single digital communications cable can carry all of these signals as well as many other variables for each channel that are produced by the machinery protection system and can be trended such as Smax, 1X amplitude, 1X phase, probe gap voltage, and others.

Thus, digital communications are preferred not only because installation costs are dramatically less, but because a much richer data set is available at the DCS and in the process historian. Indeed, "soft" alarms can be set in the DCS on some of these variables if desired to augment the alarms in the machinery protection system. In the VM600Mk2, alarms are also available inside the rack for these additional variables and do not have to be created in the DCS.

**"The cost of this (analogue) wiring can be substantial and in some cases may exceed the cost of the machinery protection system itself. In contrast, a single digital communications cable can carry all of these signals as well as many other variables for each channel that are produced by the machinery protection system and can be trended such as Smax, 1X amplitude, 1X phase, probe gap voltage, and others."**

III. Condition Monitoring Interface

The interface between the condition monitoring software and the machinery protection system is digital and uses proprietary communications. There are no exceptions to this rule, regardless of manufacturer. The reasons that proprietary protocols are used derive from the fact that most "open" industrial protocols are not designed to carry the high throughput of data entailed by the dynamic waveforms of vibration sensors.

It is generally not desirable to stream every single waveform for every shaft revolution to the condition monitoring software, and instead the monitoring hardware makes decisions regarding what data to collect and what data to send. These settings are user-configurable in most systems, including the VibroSight Suite software from vibro-meter.

IV. Combustion Dynamics Interface

For gas turbines using low-NOx combustor designs, damaging pressure pulsations can occur that will shorten the life of combustor cans if not detected and controlled. The pulsations occur because the combustion process runs as lean as possible and the flame becomes meta-stable under such conditions, creating damaging pressure pulsations when operating too close to the flame's stability margin.

On these co-called DLE (Dry Low Emissions) machines, the dynamic pressure pulsations are monitored via special filtering profiles on the signal that detect when the combustor is incurring incipient or fully manifest pulsations. When the pulsations are detected, a signal is sent to the turbine control system where the fuel/air ratio is modified to continue running the gas turbine as lean as possible, yet without remaining in a state where these damaging pulsations are present.

Because modern turbines can have more than a dozen combustors, the link between the machine protection system (where the embedded combustion dynamics monitoring occurs) and the turbine control system is generally an open, industry-standard digital communications protocol such as Profibus rather than hardwiring a dozen or more signals to convey the presence or absence of damaging pulsations in each combustor.

Although redundant digital communications can be used, in practice this link has proven to be so reliable that simplex links are today used almost exclusively when the VM600 is supplied.

The new MPC4<sup>Mk2</sup> module (left) combines machinery protection and condition monitoring on the same card, but with cybersecure segregation between the two.

The XMC16 module (right) is used to provide 16 channels of integrated combustion dynamics monitoring.

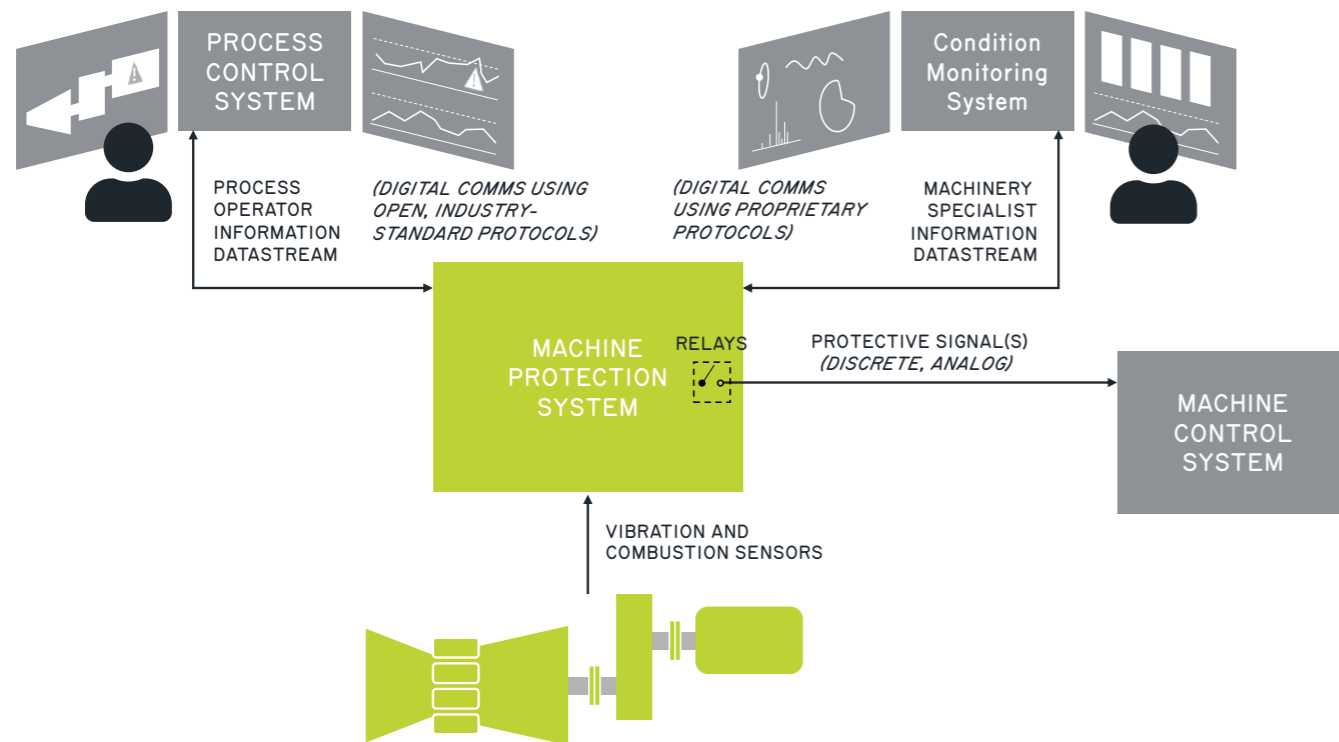

The condition monitoring interface is designed to deliver all the same data that goes to the process control system, but also dynamic waveforms that allow rotating machinery specialists to diagnose problems using rich vibration data. Proprietary protocols via industrial Ethernet are used for this purpose and considerable attention is paid to cybersecurity to ensure people accessing the system remotely are not able to compromise the machinery protective functions.

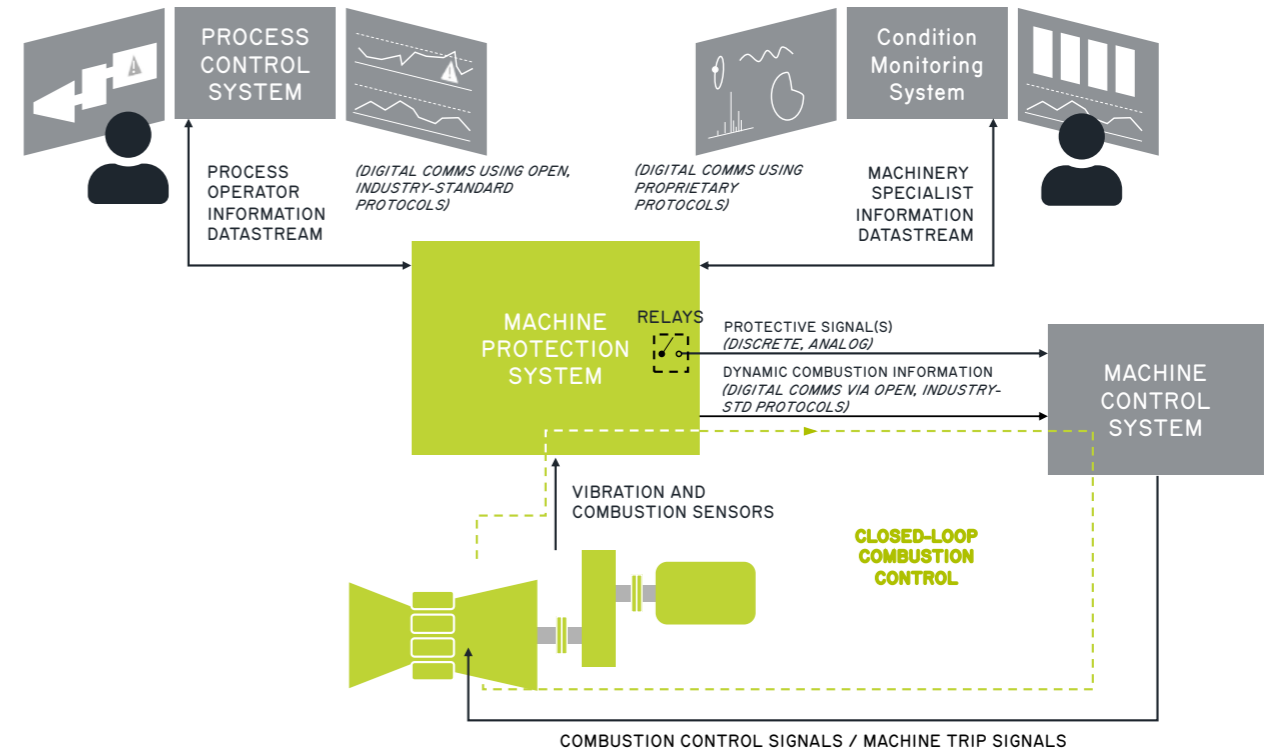

The VM600<sup>Mk2</sup> platform continues to offer integrated combustion dynamics monitoring, just as its predecessor did. Like the process control system interface, it uses an open, industry-standard protocol such as Profibus or Modbus to form closed-loop combustion control with the machine control system.



**Integrate our machinery protection systems to your broader plant.**

With the VM600<sup>Mk2</sup>, we have built on the strong foundation of our 1st generation VM600 "legacy" platform to ensure that each of the links discussed in this article are more robust and functional than ever before, yet reflecting modern cybersecurity concerns – particularly the condition monitoring interface and its segregation from machine protection.



# VM600Mk2

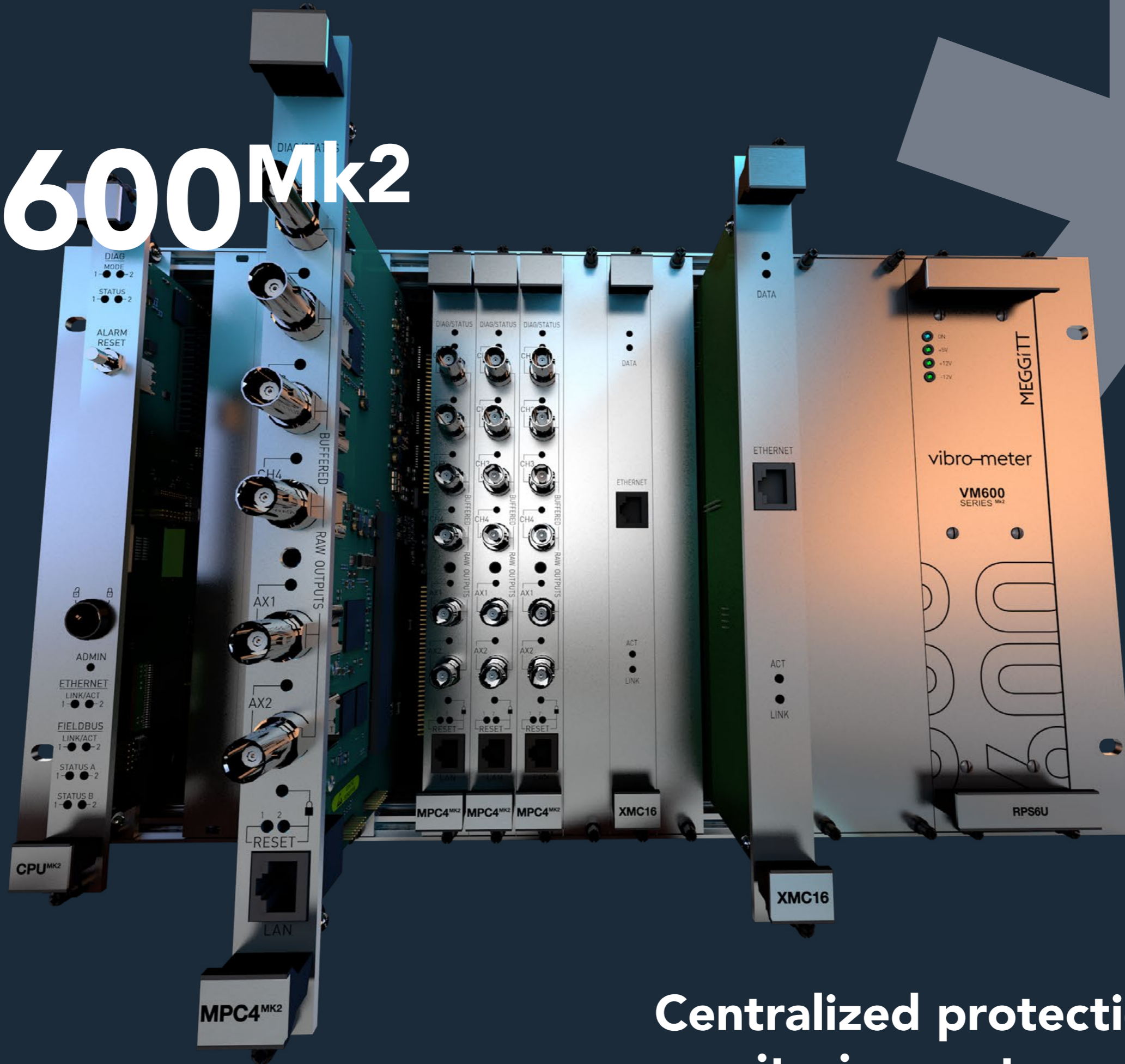

Centralized protection & monitoring system

# Features

VM600<sup>Mk2</sup>

**Ideal for applications where large rotating machinery is concentrated in one area of a plant, requiring centralized monitoring with very high channel counts**



### Accessible

Designed to centrally process a wide range of dynamic inputs coming from a variety of critical assets such as gas, steam and hydro turbines, high-value rotation machines, as well as balance of plant (BOP) equipment such as compressors, gearboxes, motors, pumps and fans



### Extended life cycle

By upgrading installed measurement chains and VM600 racks with the latest<sup>Mk2</sup> modules allows first generation users to considerably lower their total cost of ownership.

Further, replacing MPC4 with MPC4<sup>Mk2</sup> module allows condition monitoring to easily be added to existing machinery protection only systems.



### Staying power

Monitoring cards are hot-swappable so that you can keep your protection system running virtually continuously should a card fail.

Importantly, replaced modules are automatically reconfigured with the system configuration in order to minimize downtime. The requirement for spare modules is kept to a minimum.



### Increased safety and security

Locked operational mode for improved safety and security. That is, physical access to a VM600 rack is required in order to change the machinery protection system (MPS) configuration.

System-wide control signal that automatically drives all system relays and analog outputs to a safe state should the MPC4<sup>Mk2</sup> module's diagnostics (BIST) detect a problem.

#### Safety standards

- SIL 2 in accordance with IEC 61508
- API 670 5th edition machinery protection compliant
- Cybersecure in accordance with IEC 62443 (formerly ISA 99).

#### International compliance

- Europe: EU declaration of conformity (CE certificate).
- North America: cCSAus.

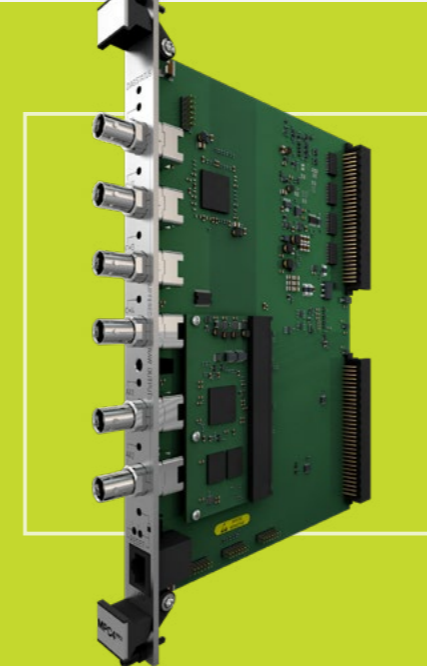
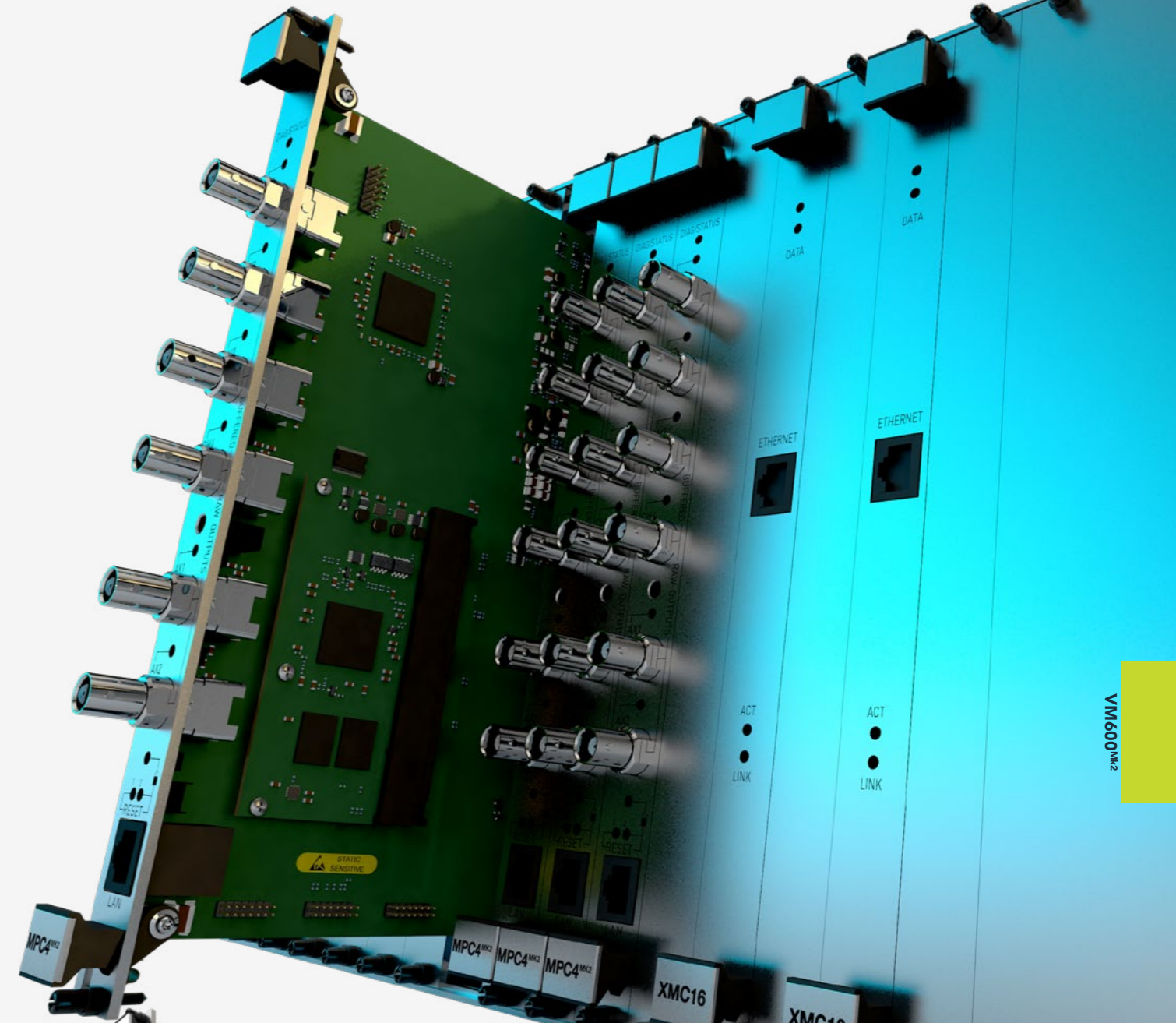

# MPC4<sup>Mk2</sup>

### Smart architecture

Machinery protection, condition monitoring functionalities are delivered from **one** module to support condition-based maintenance strategies and help reduce operating costs. In addition, the **new MPC4<sup>Mk2</sup>** module provides **integrated condition monitoring** functionality equivalent to that of a separate XMV16 module, and **completely segregates** the protective functions from the condition monitoring functions.

Like its predecessor, the **same sensors** can be **shared between protective and condition monitoring** functions via the rack's backplane.

VM600<sup>Mk2</sup>

## Architecture

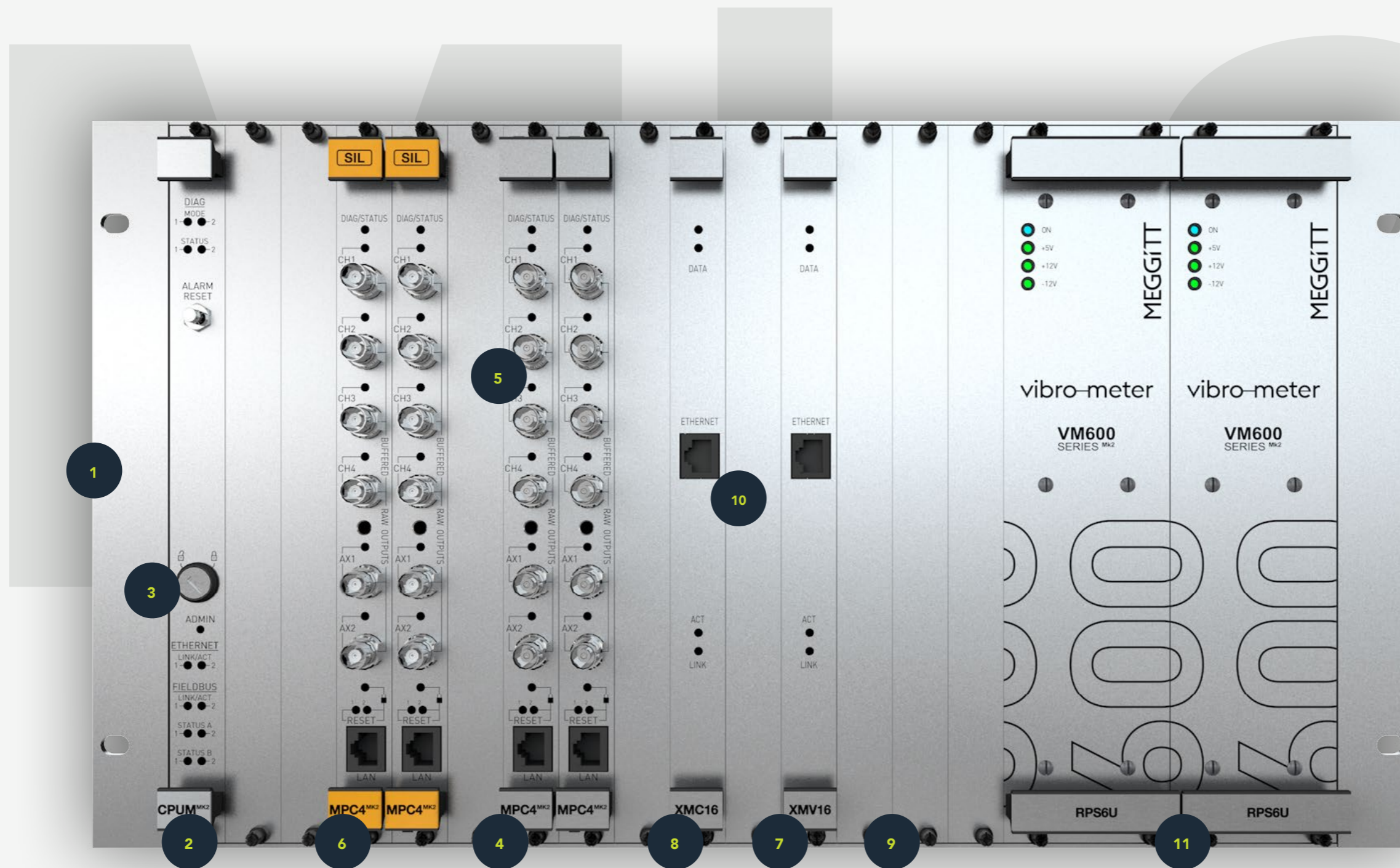
VM600<sup>Mk2</sup>

1 19" EIA chassis, 6U tall, 300mm deep, 21 slots (numbered 0-20).  
Note: also available a 19" EIA chassis, 1U tall, 311mm deep, 1 slot.

2 CPUM<sup>Mk2</sup> Communications and rack control module; supports redundant media with communications with plant control and automation platforms including PLCs, DCSs, turbine controllers, local displays, and more; supported protocols include Modbus TCP, Modbus RTU\*, Profibus DP, and Profinet\*. Cybersecure design to meet IEC 62443.

3 Keylock provides an extra measure of physical security in addition to password-protected access to configuration changes.

4 MPC4<sup>Mk2</sup> Universal vibration monitoring module provides 4 channels of dynamic signal inputs and 2 channels of speed/phase or DC inputs; provides integrated protection and condition monitoring while delivering cybersecure performance to meet IEC 62443; up to 12 modules (72 channels) per rack.

5 The MPC4<sup>Mk2</sup> is capable of specialized measurements such as generator combustion monitoring on gas turbines.

6 SIL 2 version of MPC4<sup>Mk2</sup> modules. Five on-board relays allow alarm and module fault (OK) status annunciation, suitable for auto-shutdown applications meeting SIL 2.

7 XMV16 module can be used for condition monitoring-only applications where protection is not required; allows 16 channels of high-performance condition monitoring in a single rack slot. Ideal for balance-of-plant assets, small hydro units where protection is not required, or for adding condition monitoring to existing third-party protection systems.

8 XMC16 module provides robust gas turbine combustion dynamics monitoring in the same chassis as vibration protection and condition monitoring.

9 RLC16<sup>Mk2</sup> relay expansion module provides 16 additional relays to augment the 5 relays on board each MPC4<sup>Mk2</sup> module.

10 Proprietary ethernet communications provide all dynamic and other rack signals to VibroSight software for archival, analysis, and visualization.

11 Simplex or redundant power supplies deliver all required power for rack modules and connected sensors.

# VibroSmart

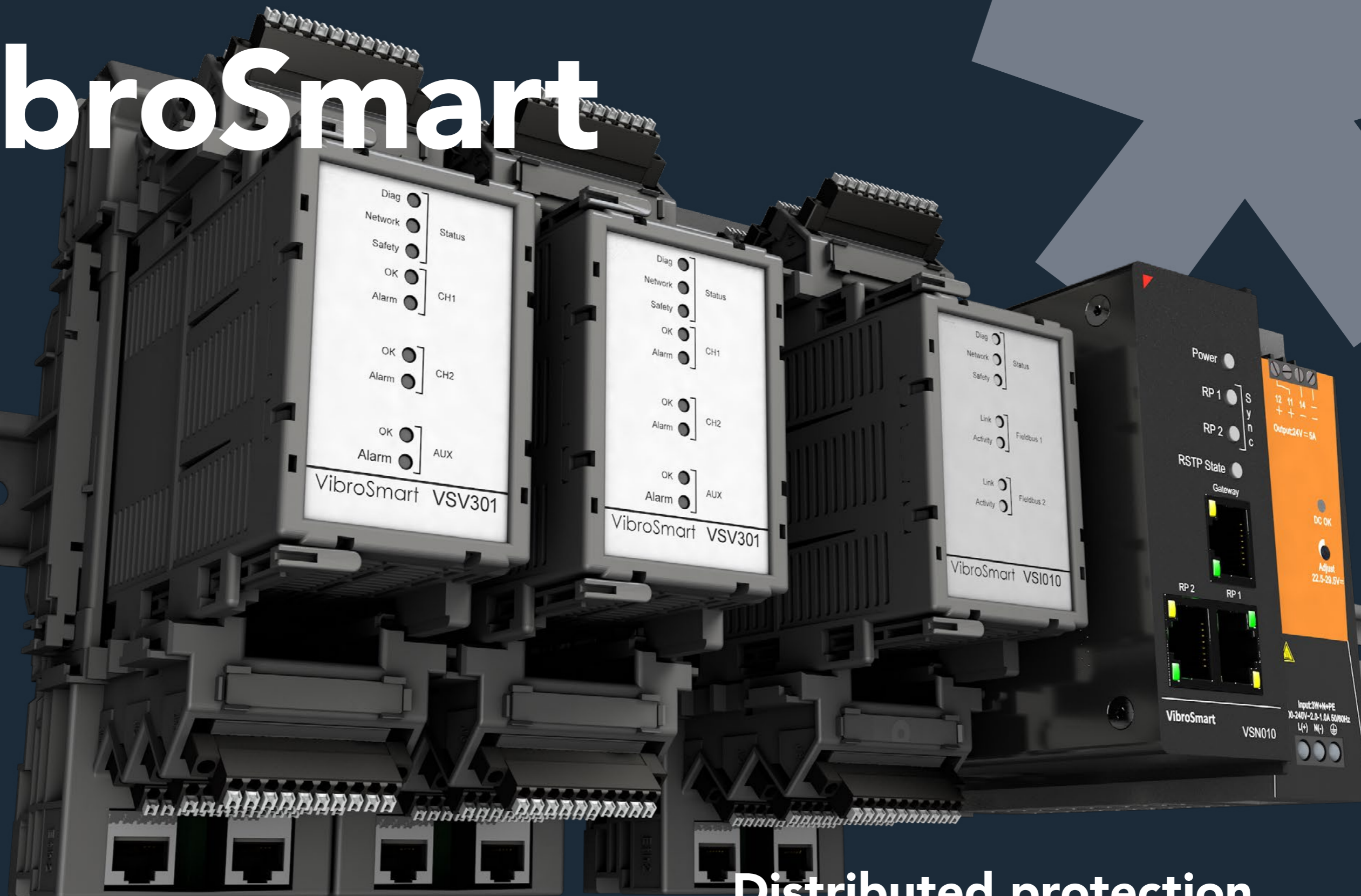

**Distributed protection  
& monitoring system**

# Features

## VibroSmart

**Ideal for plants where a distributed architecture makes sense, often involving balance of plant (BoP) machinery dispersed over large areas.**



### Machinery protection & condition monitoring

- VibroSmart's easily extended modular construction delivers first-class scalable machinery protection and condition monitoring for rotating plant.
- Comprehensive protection system, including : data acquisition and protection, relays, logical functions and analog outputs.
- Seamless redundancy: VSN010 module provides a redundant communication loop with high-availability



### Modular, scalable

- Patented real-time distributed networking monitors smaller critical assets and balance-of-plant equipment requiring low-channel count clusters.
- System can grow as monitoring or protection needs become more and more important, or new safety requirements become required.
- Simplified logical grouping for distributed applications: measurement blocks can be easily created – independence between different measurement blocks is easy to achieve.



### Low-cost installation and maintenance

- VibroSmart can be mounted directly on machinery , reducing the need for expensive sensor cabling. Modules are designed and certified to work in harsh industrial environments characterized by hazardous areas and high mechanical stress.
- Pre-wiring and pre-configuration of inexpensive terminal bases allows installation work to start earlier, then be populated with modules later on.
- Modules are hot-swappable for ease of maintenance and reduced downtime.



### Flexible & Versatile

- VibroSmart's structure is highly flexible and supports all sensor types to deliver API 670 standard machinery monitoring functions. When combined with VibroSight software, it enables detailed insights into machinery health.

#### Safety standards

- Ex certification - hazardous area safety
- PROFIsafe - for the communication interface module (VSI010 + VSB010)

#### International compliance

- EU declaration of conformity
- EAC Russian Federation declaration of conformity
- Profibus, Modbus and IEC61850 GOOSE
- IEC Standard



# Architecture

## VibroSmart

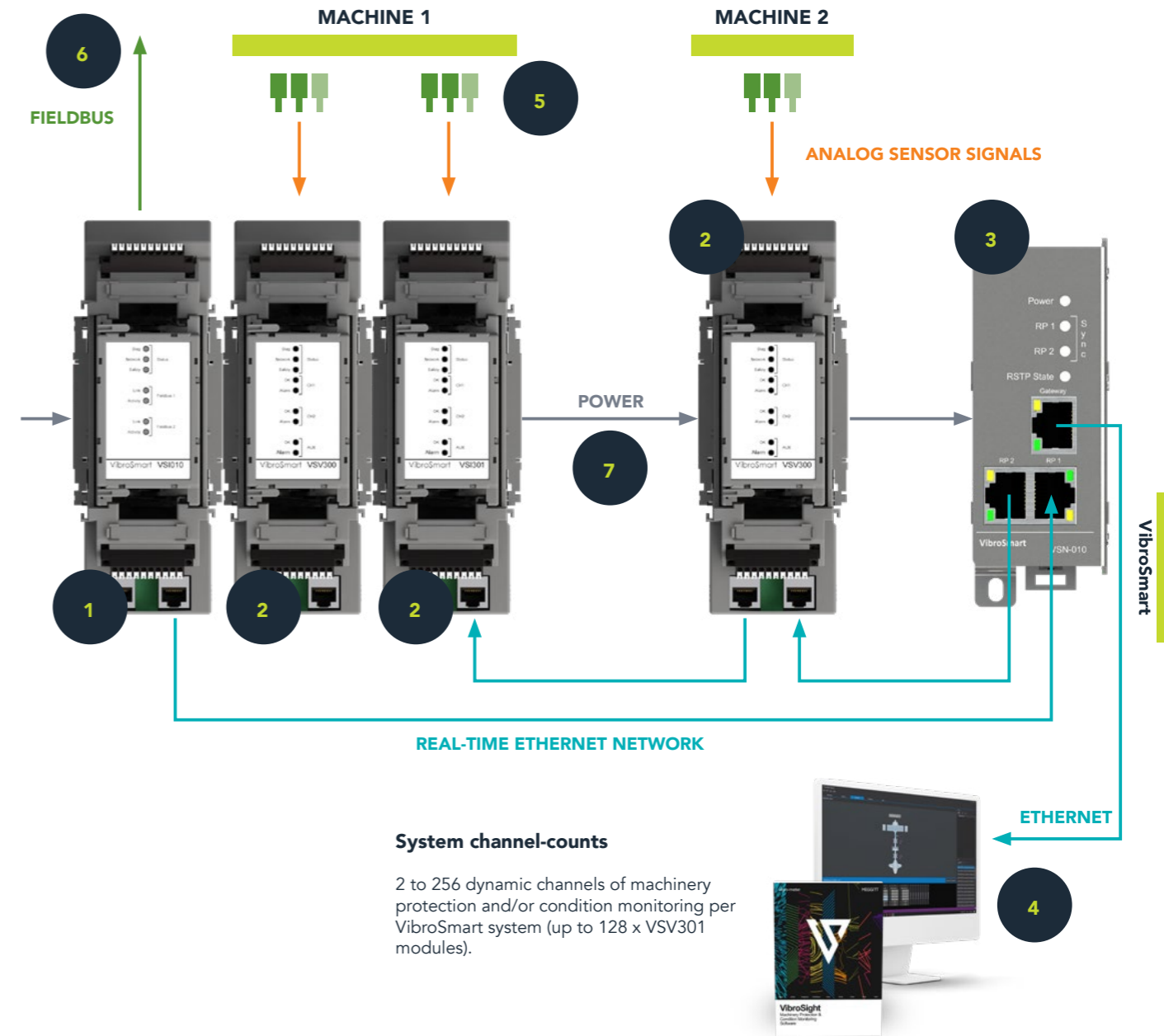

### System channel-counts

2 to 256 dynamic channels of machinery protection and/or condition monitoring per VibroSmart system (up to 128 x VSV301 modules).

- 1 VSI010: Communications interface module and terminal base with 2 fieldbuses.
- 2 VSV301: Monitoring module and terminal base with 2 dynamic channels and 1 auxiliary channel (tachometer or DC input).
- 3 VSN010: Real-time Ethernet switch enables cost-effective redundant networks (HSR ring topology) of VibroSmart modules.
- 4 VibroSight: machinery monitoring system software.
- 5 Sensors: vibro-meter or third-party sensors.
- 6 Fieldbus: Up to 2 serial fieldbus interfaces (Modbus RTU or PROFIBUS DP) or 1 Ethernet fieldbus interface (Modbus TCP). PROFIsafe safety layer to ensure more reliable PROFIBUS communications.
- 7 Power: Modules located side-by-side can communicate directly via their terminal bases that support redundant power supply distribution to improve availability.

# VibroSight



**Advanced machinery  
protection & condition  
monitoring software**

## Features

### VibroSight

**Fast and powerful, user-friendly software that enables the reliability and operational efficiency of industrial machinery.**



#### Data visualization and analysis

- Exceptional data handling and visualisation capabilities for the effortlessly fast display and analysis of data.
- Online or offline data presentation and analysis - Setup and storage of user-defined plots as projects
- Complete catalogue of plots with cursor synchronisation to allow all information relevant to a particular event or time period to be easily displayed.



#### Integrated data management

- Proprietary, highly-optimised system of VibroSight databases for outstanding performance.
- Fully-integrated support for VibroSight database management simplifies the configuration and operation of database backups, database purges and the management of offline data storage.
- Extremely easy to use data management configuration means that no external data/database management tools are required.



#### Application specific packages

- VibroSight use and navigation is deliberately simple and straightforward in order to make tasks intuitive. The software allows fast data analysis and machinery diagnosis using a comprehensive plot catalogue, featuring cursor and zoom synchronisation and fully customisable machine states including run-ups and run-downs.



#### Data import and export

- VibroSight can import data from external systems using industry standard interfaces such as Modbus and OPC.
- This allows data from third party systems such as other monitoring and/or control systems (such as a DCS or PLC) to be easily centralized in a single database for ease of data management and/or to take advantage of the speed and power of VibroSight for the display and analysis of plant-wide data.
- Equally, VibroSight can export its data using industry standard interfaces in order to share information with third-party systems.

## Architecture

### VibroSight

VibroSight is a suite of user-friendly application software modules for analyzing machinery health. It supports the flexible configuration of channels, processing, outputs, alarms and plant structure, helping to monitor the condition of all critical assets.

**“Operators can assess the overall condition of machines at a glance or use the full suite of visualization and analysis tools and plots to undertake in-depth analyses.”**

With continuous data acquisition offering seamless monitoring of even short events, VibroSight is suitable for the most stringent test-bed applications. However, configurable data-logging rules enable users to ensure they are not overwhelmed by data.

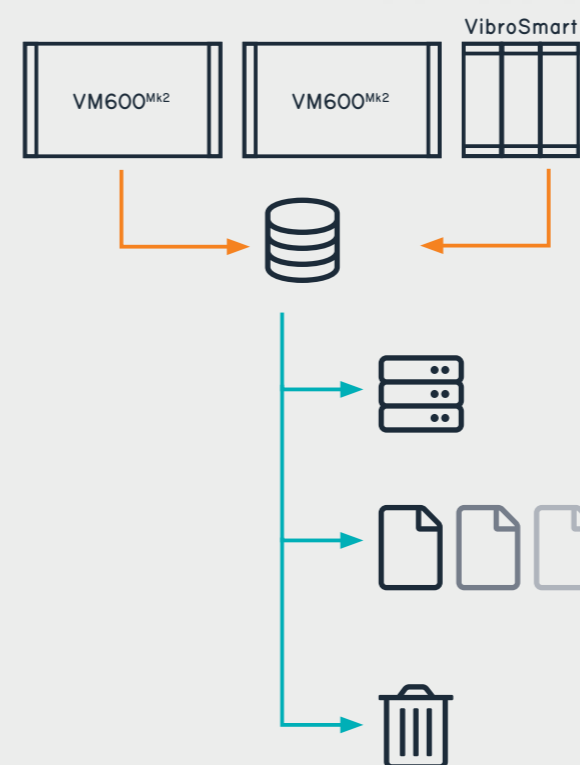
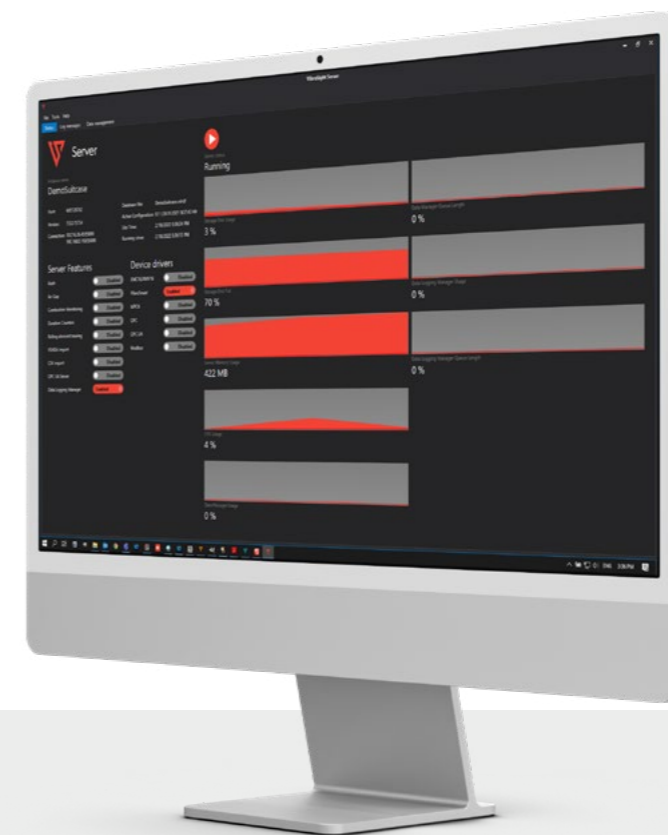

#### Monitoring Systems

VibroSight can gather data from vibro-meter VM600 racks, VibroSmart distributed monitoring systems but as well from third party systems via Modbus, OPC or CSV files.

#### Database

VibroSight doesn't require the installation and maintenance of a third party database thus simplifying the system management from the IT point of view.

#### Backup

VibroSight can automatically create an incremental database backup on a network drive to quickly recover the monitoring system from a computer catastrophic failure.

#### Historical data files

The data from the database can be periodically downselected and copied over automatically to historical data files that can be used to create a mirrored database at a different location or for longer term storage.

#### Purge

The database size can be maintained under control by automatically deleting the oldest data from the database.

# Applications

## VibroSight

# System configuration

### EventViewer

Monitoring of alarms and system events  
Allows the monitoring of alarms and system events from monitoring systems or stored in VibroSight databases.



### Mimic

Machine operator interface  
Provides an overview of the machinery being monitored using live measurement data.



# Management

### Server

Data logging, management & sharing  
Data logging into the database and provides data access to all VibroSight suite applications and third party software.



### System manager

System maintenance  
Allows system maintenance tasks like module firmware upgrades or configuration of IP addresses and NTP settings.



### Protect

Machinery protection configurator  
For the configuration of machinery protection functionality.



### Capture

Condition monitoring configurator  
For the configuration of condition monitoring functionality.



# Monitoring

### Vision

Data visualization & analysis  
Features a comprehensive plot catalog to display and analyse live or historical data from monitoring systems or stored in VibroSight databases.



**Adopted by major gas-turbine OEMs as their fleet standard for combustion and vibration monitoring, VibroSight is actively developed and maintained with at least three new software releases per year including new features and improvements.**

### Protect: machinery protection configurator

VibroSight Protect is a software tool exclusively dedicated to the configuration and commissioning of machinery protection systems. It has been designed to naturally guide the user through the configuration of all the protection chain components (input channels, processing functions, alarms, logical functions and relays) in a very user friendly way to avoid any potential misconfigurations that could end in a miss-strip or a false-trip.

### Capture: condition monitoring configurator

In VibroSight Capture the user can configure the condition monitoring capabilities without being able in any way to impact the machinery protection function either intentionally or by pure mistake. The configuration workflow uses as reference point the modelling and layout of the machine trains under surveillance. The condition monitoring settings include condition monitoring processing functions and software alarms, database logging, database management, data import and export.

### Vision: data visualization & analysis

VibroSight Vision offers easy to use data handling and visualisation capabilities so that it is effortlessly fast for the display and analysis of data. It includes a complete catalogue of plots with cursor synchronisation that allows all of the information relevant to a particular event or time period to be more easily displayed for even quicker analysis. Data from multiple VibroSight databases (\*.vsdha) can be worked with at the same time using simple drag and drop operations in order to more easily compare present and historical data across multiple sites and time periods.

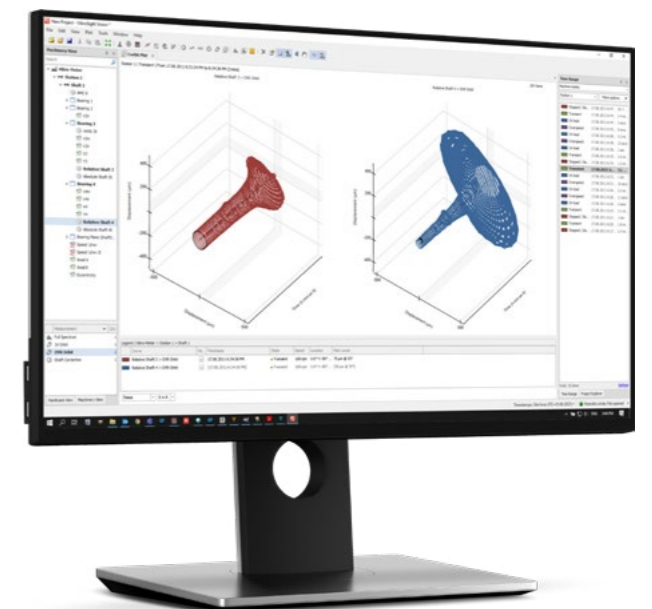
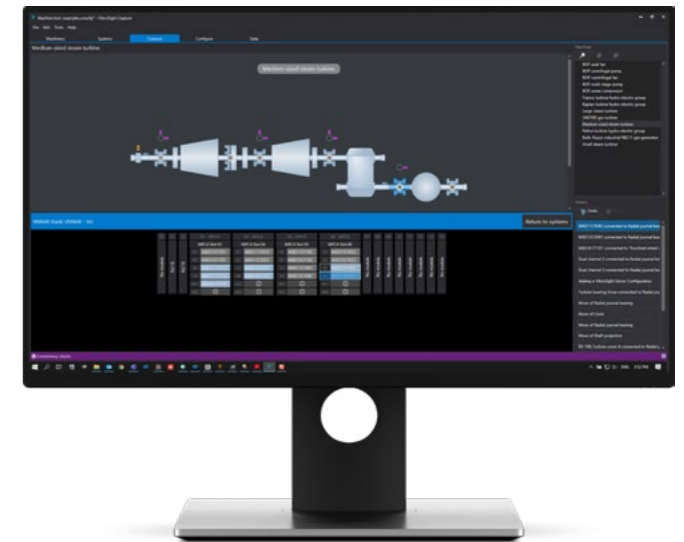
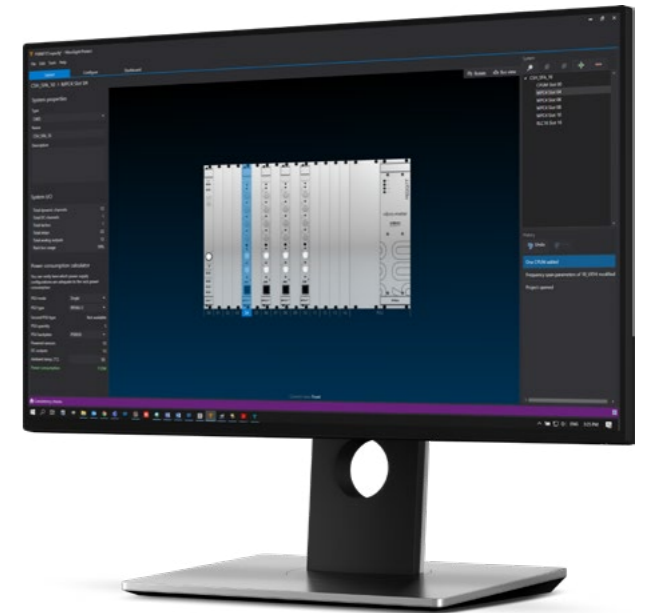



# MEGGITT

## **About us**

Meggitt pioneered high performance sensing and condition monitoring solutions for extreme environments. After working with the world's turbine manufacturers for more than 60 years, Meggitt through vibrometer portfolio remains master of all aspects of the condition monitoring and machinery protection disciplines.

From high performance sensing, data acquisition and management to the high speed digital networking and the signal processing algorithms that can deliver diagnostics for prescriptive maintenance solutions.

## **Meggitt PLC**

Headquartered in the United Kingdom, Meggitt PLC is an international group operating in North and South America, Europe and Asia. Known for its specialised extreme environment engineering, Meggitt is a world leader in aerospace, energy and defence markets. An 11,000-strong workforce serves customers from around 40 manufacturing facilities and regional offices worldwide.

## **Contact information**

Route de Moncor 4  
Case postale 1702  
Fribourg Switzerland

[www.meggittsensing.com/energy](http://www.meggittsensing.com/energy)  
[www.linkedin.com/vibro-meter](http://www.linkedin.com/vibro-meter)